

LUXOR

D O U B L E

sagI



# DOUBLE RANGE

## EVOLUZIONE INEVITABILE: LUXOR DIVENTA DOUBLE

L'accattivante design e la straordinaria versatilità la rendono speciale, unica nel panorama dell'esposizione verticale refrigerata.

Disponibile in due versioni, **free-standing** e **built-in**, risponde elegantemente alle nuove esigenze di arredo e di consumo.

Grazie al vano espositivo completamente in vetro camera temprato con esterno serigrafato, all'innovativo sistema reggi ripiani ed all'illuminazione a led, Luxor Double è espressione di luce e massima visibilità del contenuto. La struttura raffinata e le dimensioni, magistralmente studiate, permettono di esporre in totale libertà moltiplicando lo spazio disponibile! Il sistema Softmotion di apertura pneumatica a ribalta delle ante in vetro camera temprato riduce i consumi energetici aumentando la flessibilità di utilizzo e la migliore valorizzazione dell'esposizione.

L'ESPOSIZIONE CHE SI ADATTA AD OGNI  
ESIGENZA

## INEVITABLE EVOLUTION: LUXOR BECOMES DOUBLE

Attractive design and extraordinary versatility make it special, unique in the world of upright refrigerated display units.

Available in two models, **free-standing** and **built-in**, elegantly meets contemporary needs in terms of furnishing and consumer products.

Thanks to its display compartment, entirely in tempered glass with external screen-silk printing, innovative shelf holder system and LED lighting, Luxor Double is an expression of light and maximum content visibility. The sophisticated superbly designed structure and dimensions allow for display with total confidence, optimising the space available! The Softmotion pneumatic flapdoor opening system in tempered glass reduces energy consumption, increasing flexibility of use and offers optimum display value.

DISPLAY THAT ADAPTS TO EVERY NEED



reddot design award  
honourable mention 2012



AEG

# LUXOR

D O U B L E

f r e e - s t a n d i n g



Design by  
MASSIMO MUSSAPPI



- Vano espositivo in vetro temprato con illuminazione a led; struttura inferiore in acciaio speciale antimpronta dotata di ruote "invisibili" piroettanti
- Display compartment in tempered glass with LED lighting; lower structure in special anti-fingerprint steel with "invisible", swivelling wheels

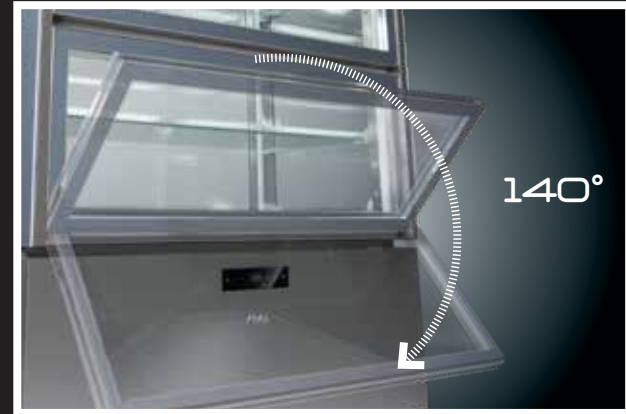

- Sistema Softmotion di apertura pneumatica a ribalta delle ante
- Softmotion pneumatic flapdoor opening system

## DOUBLE CHOICE

free-standing **REVERSE**...

free-standing



SIDE A



SIDE B



SIDE A



SIDE B

- Design per la massima flessibilità nell'esposizione: Double **Side** Double **Face**  
Scheda comandi elettronica in vetro nero con tasti capacitivi ed allarmi HACCP
- Design for maximum display flexibility: Double **Side** Double **Face**  
Black glass electronic panel control board with touch keys and HACCP alarms



# LUXOR

D O U B L E

built-in



## L'ELEGANZA SU MISURA

Luxor Double built-in è nata per permettere di arredare in modo unico e con stile ogni ambiente. I moduli da incasso offrono la massima versatilità nella progettazione di un locale. Le caratteristiche della gamma Luxor Double, unite alla progettazione speciale del vano inferiore, permettono ai singoli modelli di essere completamente personalizzati.

## TAILOR-MADE ELEGANCE

Luxor Double built-in was created for the unique and stylish presentation of any environment. The built-in modules offer maximum versatility in the design of a shop. The features of the Double Luxor range, combined with the distinctive design of the lower compartment, allow individual models to be fully customised.

\* Foto realizzate con modelli KP12Q1M e KP12Q2M  
Photos created using the models KP12Q1M and KP12Q2M







- Vano espositivo in vetro temprato con illuminazione a led; trasparenza totale e visibilità piena del prodotto anche dall'alto
- Display compartment in tempered glass with LED lighting, complete transparency and full visibility also of the product from above



- Sistema Softmotion di apertura pneumatica a ribalta delle ante
- Softmotion pneumatic flapdoor opening system





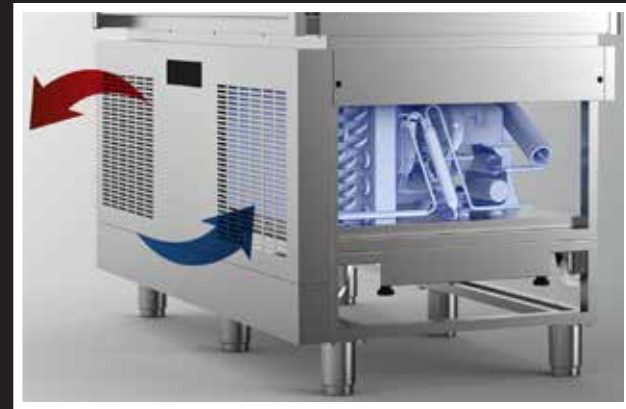













- Struttura inferiore da incasso da pannellare  
Piedi regolabili in altezza  
Per i modelli KD12Q2M e KD12Q1M consultare la documentazione tecnica
- Built-in lower structure to be panelled  
Height-adjustable support feet  
See technical documentation for models KD12Q2M and KD12Q1M



- Nei modelli KP12Q2M, KP12Q1M, KC12Q2M e KC12Q1M, circolazione ad "U" dell'aria per la massima flessibilità nella personalizzazione
- "U"-path air circulation for maximum customisation flexibility for models KP12Q2M, KP12Q1M, KC12Q2M and KC12Q1M

# DOUBLE

free-standing

	KP12Q	KP12QF	KP12Q2	KP12Q2F	KD12Q2	KC12Q2
	+2 / +10	+2 / +10	+2 / +10	+2 / +10	-20 / +5	+14 / +16
	+30	+30	+30	+30	+30	+30
						
	70	70	70	70	60÷35	40÷44
	Ad aria/by air	Ad aria/by air	Ad aria/by air	Ad aria/by air	A gas caldo / by hot gas	Ad aria/by air
	n° 6 cm 41 x 107	n° 6 cm 41 x 107	n° 4 cm 41 x 107	n° 4 cm 41 x 107	n° 4 cm 41 x 107	n° 4 cm 41 x 107
	•	•	•	•	•	•
	811	811	536	536	536	536
	320/355	320/355	260/292	260/292	275/307	260/292
	1120	1120	1120	1120	1800	1120

Fluido refrigerante: R404A. Possibilità di carico per singolo ripiano in vetro fino a 20 kg.

Refrigerating fluid R404A. Possibility of loading up to 20 kg per shelf.

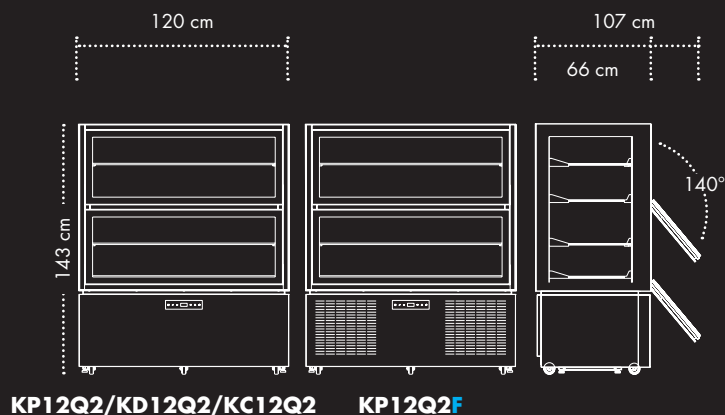
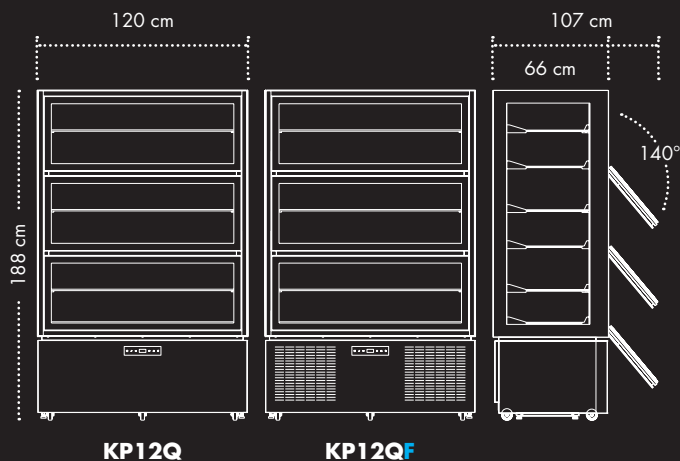

# SPECIFICATIONS

built-in

	KP12Q1M	KP12Q2M	KD12Q1M	KD12Q2M	KC12Q1M	KC12Q2M	KP12Q1R	KP12Q2R
	+2 / +10	+2 / +10	-20 / +5	-20 / +5	+14 / +16	+14 / +16	+2 / +10	+2 / +10
	+30	+30	+30	+30	+30	+30	+30	+30
	70	70	60÷35	60÷35	40÷44	40÷44	70	70
	Ad aria/by air	Ad aria/by air	A gas caldo / by hot gas	A gas caldo / by hot gas	Ad aria/by air	Ad aria/by air	Ad aria/by air	Ad aria/by air
	n° 2 cm 41 x 107	n° 4 cm 41 x 107	n° 2 cm 41 x 107	n° 4 cm 41 x 107	n° 2 cm 41 x 107	n° 4 cm 41 x 107	n° 2 cm 41 x 107	n° 4 cm 41 x 107
	•	•	•	•	•	•	-	-
	255	536	255	536	255	536	255	536
	215/237	275/307	270/289	300/322	215/237	275/307	200/222	230/255
	1120	1120	1800	1800	1120	1120	1125*	1125*

\*Potenza frigorifera se collegato a gruppo remoto Sagi GRKP12

Fluido refrigerante: R404A. Possibilità di carico per singolo ripiano in vetro fino a 20 kg. Per i modelli built-in: in caso di accostamento dei prodotti si consiglia di contattare il costruttore.

\*Cooling unit if connected to Sagi cooling unit mod. GRKP12

Refrigerating fluid R404A. Possibility of loading up to 20 kg per shelf. With built-in models: for combination of products, it is advisable to contact the company.

Modelli KD...M: per la realizzazione dei pannelli consultare il costruttore oppure scaricare i documenti tecnici su [www.sagispa.it](http://www.sagispa.it)  
Models KD...M: for the production of the panels, please contact the manufacturer or download the technical documentation from [www.sagispa.it](http://www.sagispa.it)

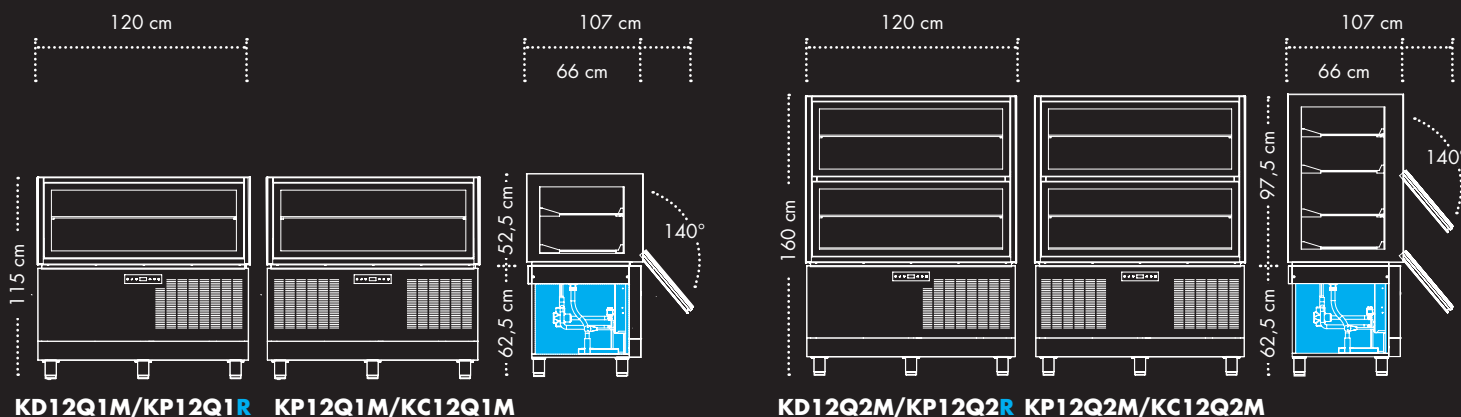



**100%**  
Made in Italy



**SAGI**

A Marmon  
Berkshire Hathaway Company

**Sagi SpA con socio unico**

Zona Industriale Campolungo 79/81  
63100 Ascoli Piceno - Italy

Tel. +39 0736 22601 - Fax +39 0736 226065  
marketing@sagispa.it - www.sagispa.it

Il costruttore si riserva il diritto di apportare al prodotto modifiche tecniche e di design senza preavviso  
The manufacturer reserves the right to make technical changes to the product and design without notice

cpvcd.it (11/17) 7Y20061